

Data sheet

Commercial Art.No.: 25.350.3253.0

PCB pin header 8213 S / 2 G OB

PCB pin header, connection method depends on used socket part , 2 poles, pitch: 5.08 mm, type of packing: carton, color: grey



Certificates / Approvals



Technical data

General

Modular spacing	5.08 mm
Soldering process	Wave soldering
Packaging	Carton
Number of poles	2
Number of levels	1
Marking	No
Fastening	None
Mating direction towards (circuit) board	90°

Technical data

Rated current	12 A
Overvoltage Category I	1000 V
Overvoltage Category II	400 V
Overvoltage Category III	250 V
Rated impulse voltage	4 kV

Technical Data UL/CSA

Voltage UL	300 V
Current field wiring	15 A
Current factory wiring	15 A
Voltage CSA	300 V
Current CSA	15 A

Other

Type of insulation material	Thermoplastic
Color	Grey
Height	12 mm
Length	11.56 mm
Depth	8.4 mm
Material contact base	CuZn

Material contact surface	Sn
--------------------------	----

Classification

ECLASS 11	
ECLASS 8.1	27440402
ETIM 7.0	EC002637
ETIM 6.0	EC002637
ETIM 5.0	EC002637
ETIM 4.0	EC002637

Product compliance

ROHS conformity status	Compliant
REACH-SVHC conformity status	Compliant

für folgende Tabellen-Zchnng.:
25.350.3253.0 8213 S/...G

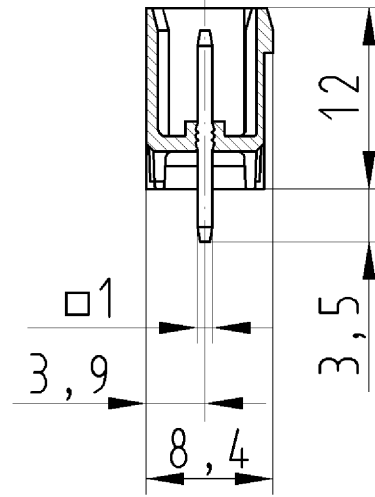
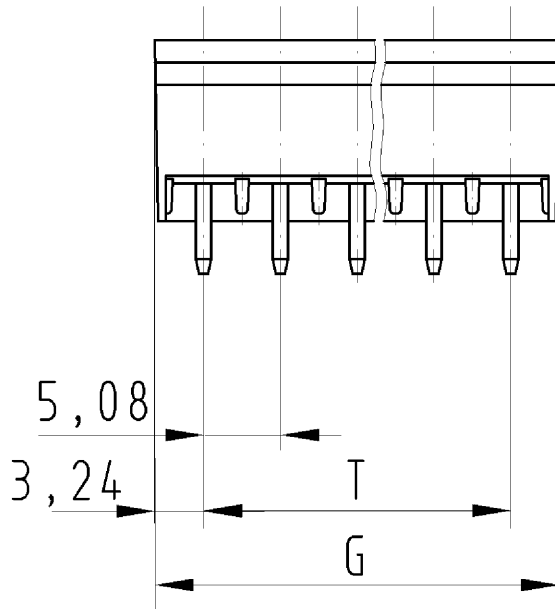

LP.STIFTLEISTE
25.350.3253.0 10W
19.10.2007 SCJ
M 2:1